

# *KillTest*

質量更高 服務更好



## 學習資料

<http://www.killtest.net>

一年免費更新服務

**Exam** : **640-444**

**Title** : Cisco IP Telephony (CIPT)

**Version** : Demo

1. Which four characteristics would typically be used to define a device pool? (Choose four.)

- A. geographic proximity
- B. common use of codecs
- C. common MOH source
- D. common device type
- E. common class of service
- F. common calling search spaces for auto-registration

Answer:ABCF

2. What method of Call Admission Control (CAC) is used for centralized call processing? A. locations

- B. regions
- C. gatekeeper
- D. H.225
- E. gateway
- F. H.323

Answer:A

3. Two options exist for adding a gatekeeper-controlled trunk to support gatekeeper call administration control. Which two of the following options could be selected to configure the trunk type as shown in the exhibit? (Choose two.)

The screenshot shows the Cisco CallManager Administration web interface. At the top, there is a navigation menu with the following items: System, Route Plan, Service, Feature, Device, User, Application, and Help. Below the navigation menu is a banner with the text "Cisco CallManager Administration" and "For Cisco IP Telephony Solutions". The main heading of the page is "Add a New Trunk". Below the heading, there is a prompt: "Select the type of Trunk you would like to create :". There are two dropdown menus: "Trunk type\*" and "Device Protocol\*". Below the dropdown menus, there is a note: "\* indicates required item" and a "Next" button.

```
Partition = Phones

Partition = Service
  Route Pattern X11

Partition = Local
  Route Pattern X11
  Route Pattern 9.0

Partition = LongDistance
  Route Pattern X11
  Route Pattern 9.[2-9]XXXXXX
  Route Pattern 9.1[2-9]XX[2-9]XXXXXX

Partition = International
  Route Pattern 9.011!
```

```
CSS A
  Phones
  Service
```

```
CSS B
  Service
  Local
  LongDistance
```

```
CSS C
  LongDistance
```

```
CSS D
  Phones
  LongDistance
```

```
Partition = Phones

Partition = Service
  Route Pattern X11

Partition = Local
  Route Pattern X11
  Route Pattern 9.0

Partition = LongDistance
  Route Pattern X11
  Route Pattern 9.[2-9]XXXXXX
  Route Pattern 9.1[2-9]XX[2-9]XXXXXX

Partition = International
  Route Pattern 9.011!
```

```
CSS A
  Phones
  Service
```

```
CSS B
  Service
  Local
  LongDistance
```

```
CSS C
  LongDistance
```

```
CSS D
  Phones
  LongDistance
```

**Cisco CallManager Administration**  
For Cisco IP Telephony Solutions

**CISCO SYSTEMS**

## Translation Pattern Configuration

[Add a New Translation Pattern](#)  
[Back to Find/List Translation Patterns](#)

Translation Pattern: 2XX  
Status: Ready

### Pattern Definition

|   |   |
|---|---|
| Translation Pattern   | <input type="text" value="2XX"/>  |
| Partition   | <input type="text" value="P_CallsFromRoomToRoom"/>  |
| Description   | <input type="text" value="RoomCallingRoom"/>  |
| Numbering Plan*   | <input type="text" value="North American Numbering Plan"/>  |
| Route Filter  | <input type="text" value="&lt; None &gt;"/>   |
| Calling Search Space  | <input type="text" value="CSS_Room"/>   |
| MLPP Precedence   | <input type="text" value="Default"/>  |
| Route Option  | <input checked="" type="checkbox"/> Route this pattern<br><input type="checkbox"/> Block this pattern <input type="text" value="-- Not Selected --"/> |
| <input checked="" type="checkbox"/> Provide Outside Dial Tone | <input checked="" type="checkbox"/> Urgent Priority   |

### Calling Party Transformations

Use Calling Party's External Phone Number Mask

|                                |   |
|--------------------------------|---|
| Calling Party Transform Mask   | <input type="text"/>                    |
| Prefix Digits (Outgoing Calls) | <input type="text"/>                    |
| Calling Line ID Presentation   | <input type="text" value="Restricted"/> |
| Calling Name Presentation      | <input type="text" value="Restricted"/> |

### Connected Party Transformations

|                                |   |
|--------------------------------|---|
| Connected Line ID Presentation | <input type="text" value="Restricted"/> |
| Connected Name Presentation    | <input type="text" value="Restricted"/> |

### Called Party Transformations

|                                |   |
|--------------------------------|---|
| Discard Digits                 | <input type="text" value="&lt; None &gt;"/> |
| Called Party Transform Mask    | <input type="text"/>                        |
| Prefix Digits (Outgoing Calls) | <input type="text"/>                        |

\* indicates required item.

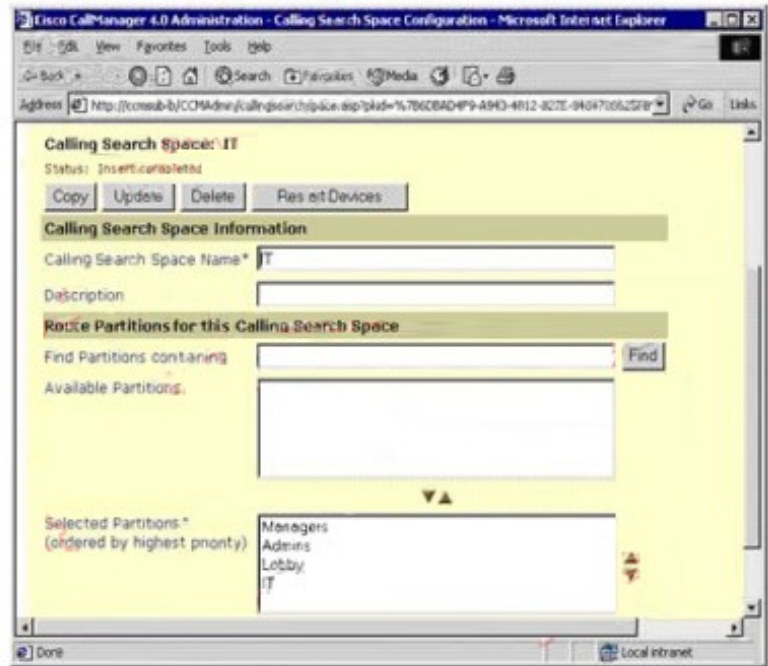
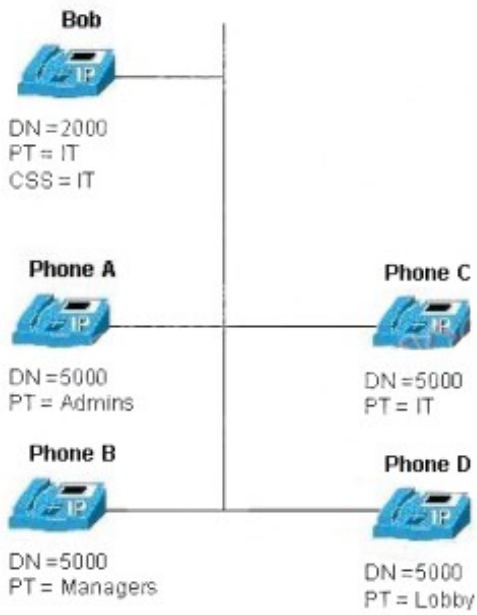

## Region Configuration

[Add a New Region](#)  
[Back to Find/List Regions](#)  
[Dependency Records](#)

Region: Saint Petersburg

Status: Ready

### Region Information

Region Name\*

### Call Information

The maximum audio codec/video bandwidth supported within this region and between 2 other regions are:

| Region                                   | Audio Codec                        | Video Call Bandwidth  |
|--|------------------------------------|---|
| Australia                                | <input type="text" value="G.729"/> | <input checked="" type="radio"/> None <input type="radio"/> <input type="text" value=""/> kbps    |
| Madison                                  | <input type="text" value="G.729"/> | <input type="radio"/> None <input checked="" type="radio"/> <input type="text" value="384"/> kbps |
| Saint Petersburg<br>(Within this Region) | <input type="text" value="G.711"/> | <input type="radio"/> None <input checked="" type="radio"/> <input type="text" value="384"/> kbps |

## Location Configuration

[Add a New Region](#)  
[Back to Find/List Regions](#)  
[Dependency Records](#)

Location: Madison

Status: Ready

### Location Information

Location Name\*

### Audio Calls Information

Audio Bandwidth\*  Unlimited   kbps

If the audio quality is poor or choppy, lower the bandwidth setting. For ISDN use multiples of 56 kbps or 64 kbps.

### Video Calls Information

Video Bandwidth\*  None  Unlimited   kbps

|                                     |               |
|-------------------------------------|---------------|
| Partition = IP Phones               | CSS A         |
| Partition = Service                 | IP Phones     |
| Route Pattern [2-9]11               | Service       |
| Partition = Local                   | Local         |
| Route Pattern 9.[2-9]XXXXXX         | CSS B         |
| Partition = Long Distance           | Service       |
| Route Pattern 9.1[2-9]XX[2-9]XXXXXX | Local         |
| Partition International             | CSS C         |
| Route Pattern 9.011!                | Long Distance |
|                                     | CSS D         |
|                                     | IP Phones     |
|                                     | Service       |
|                                     | Local         |
|                                     | Long Distance |

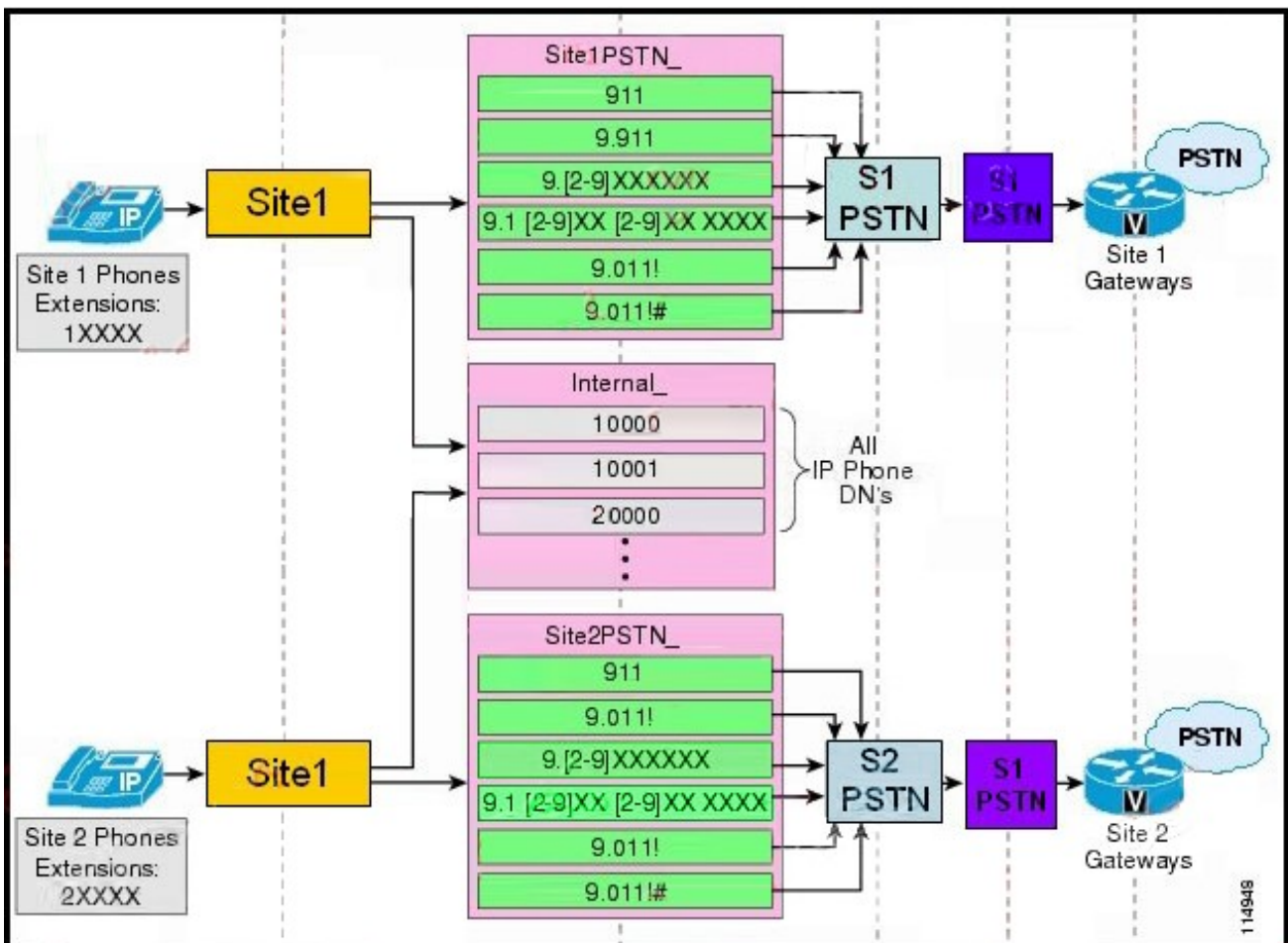



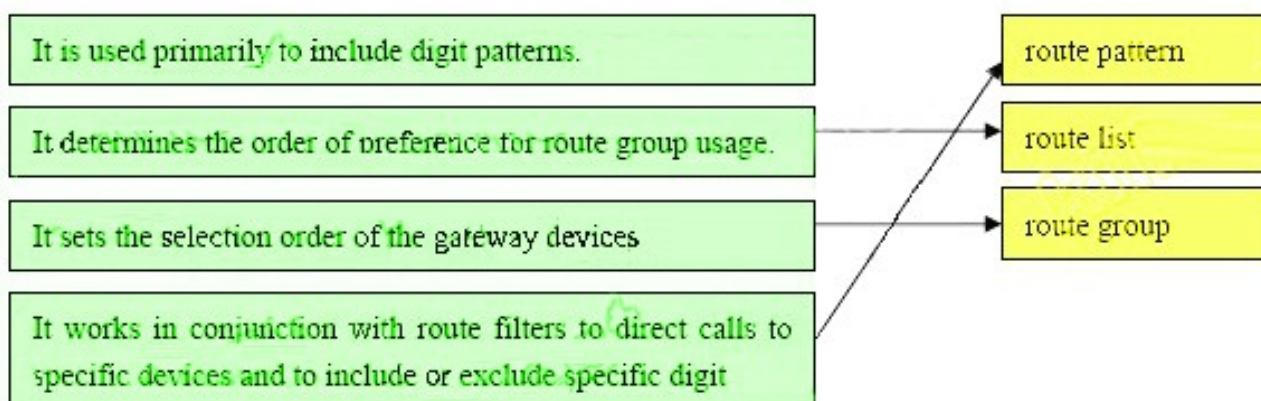
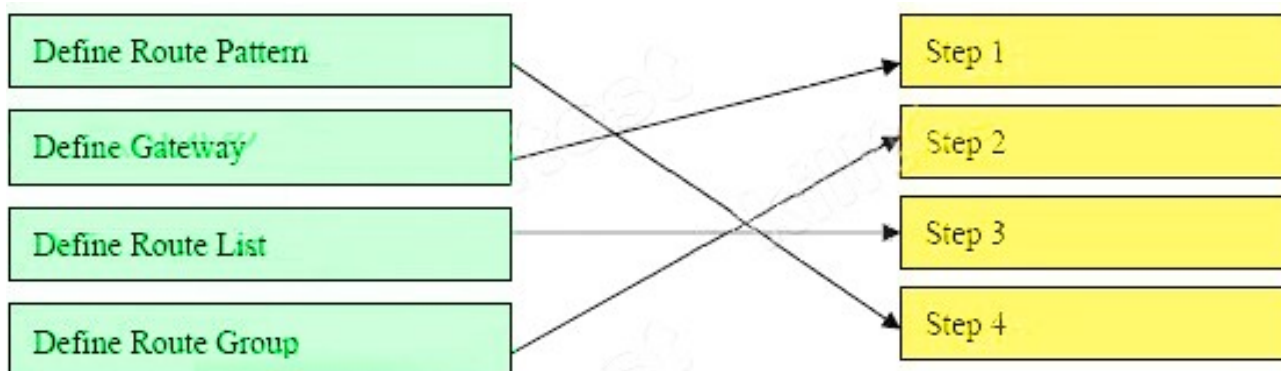
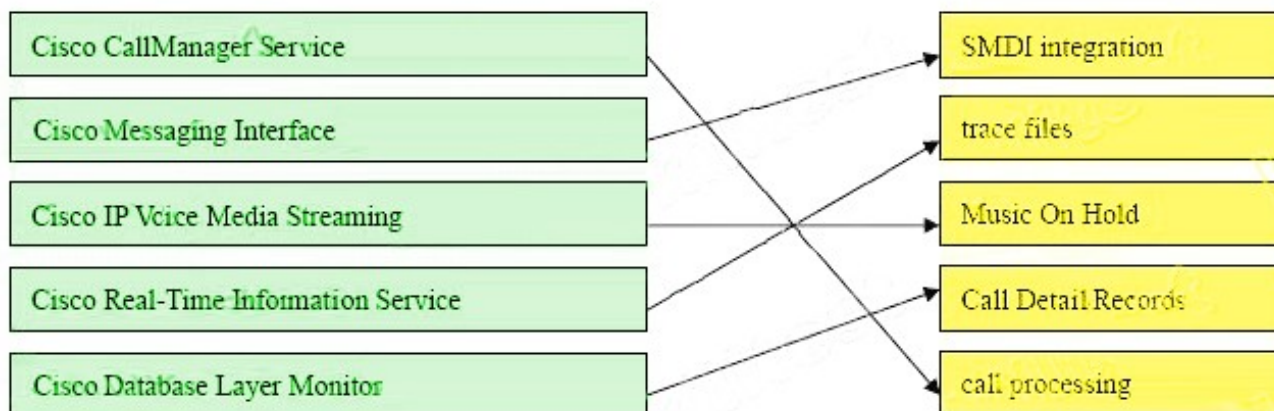

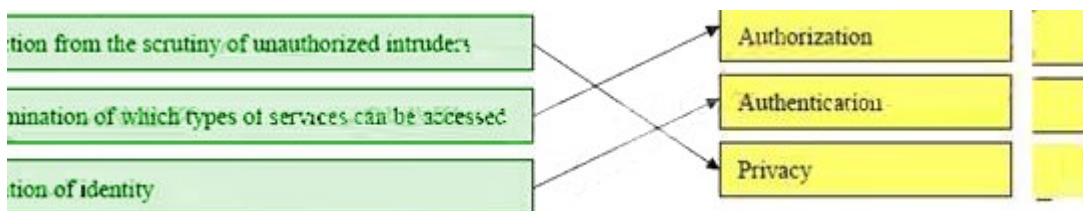
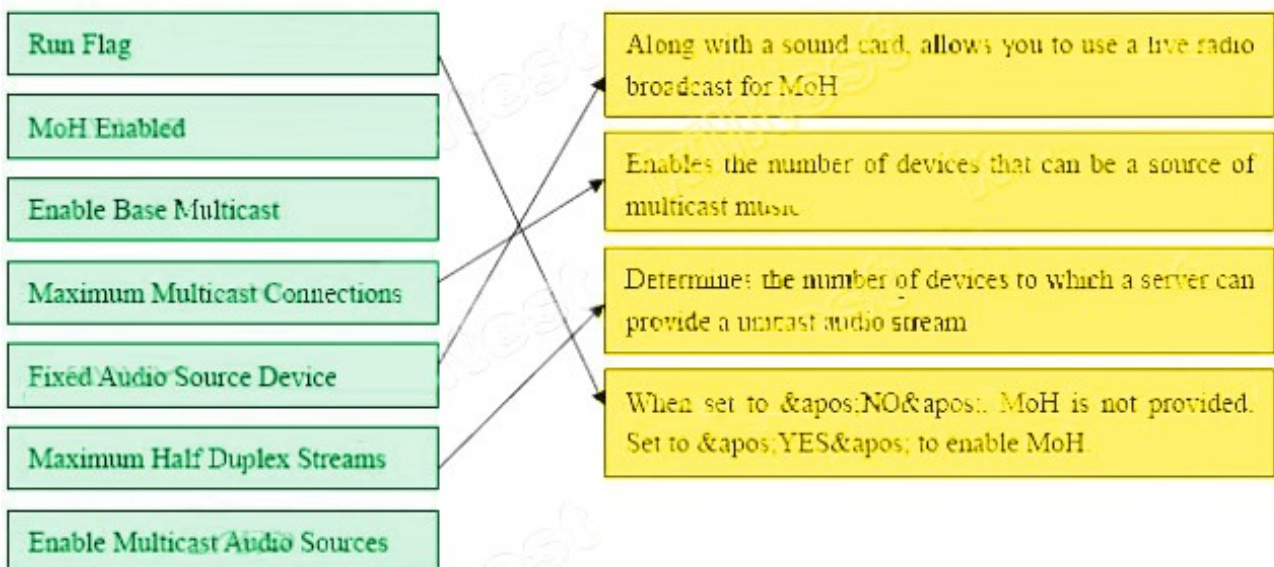
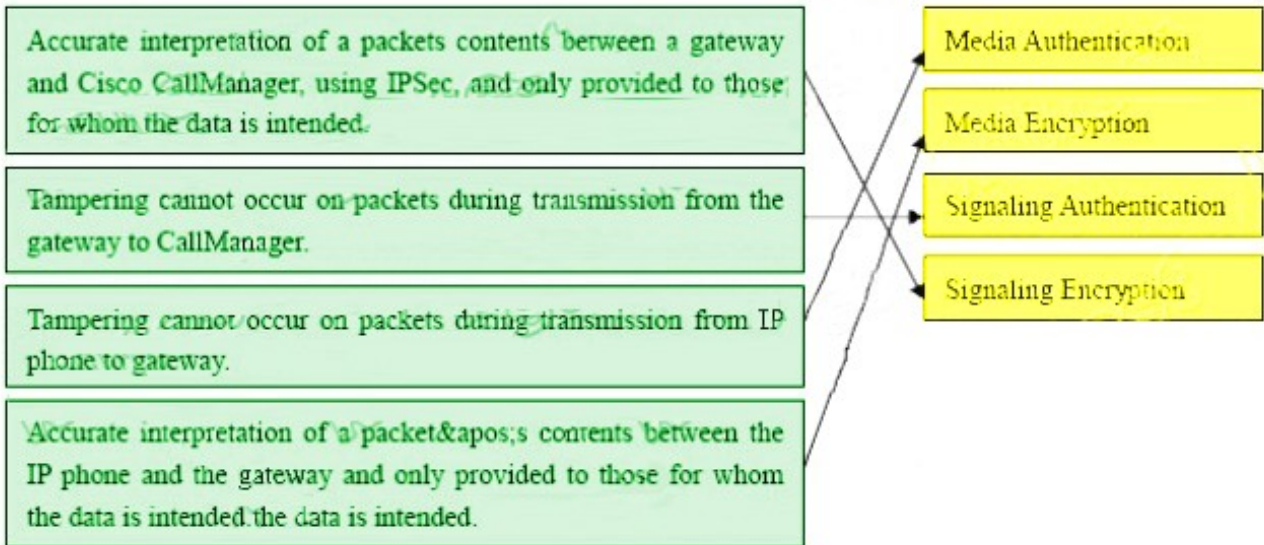

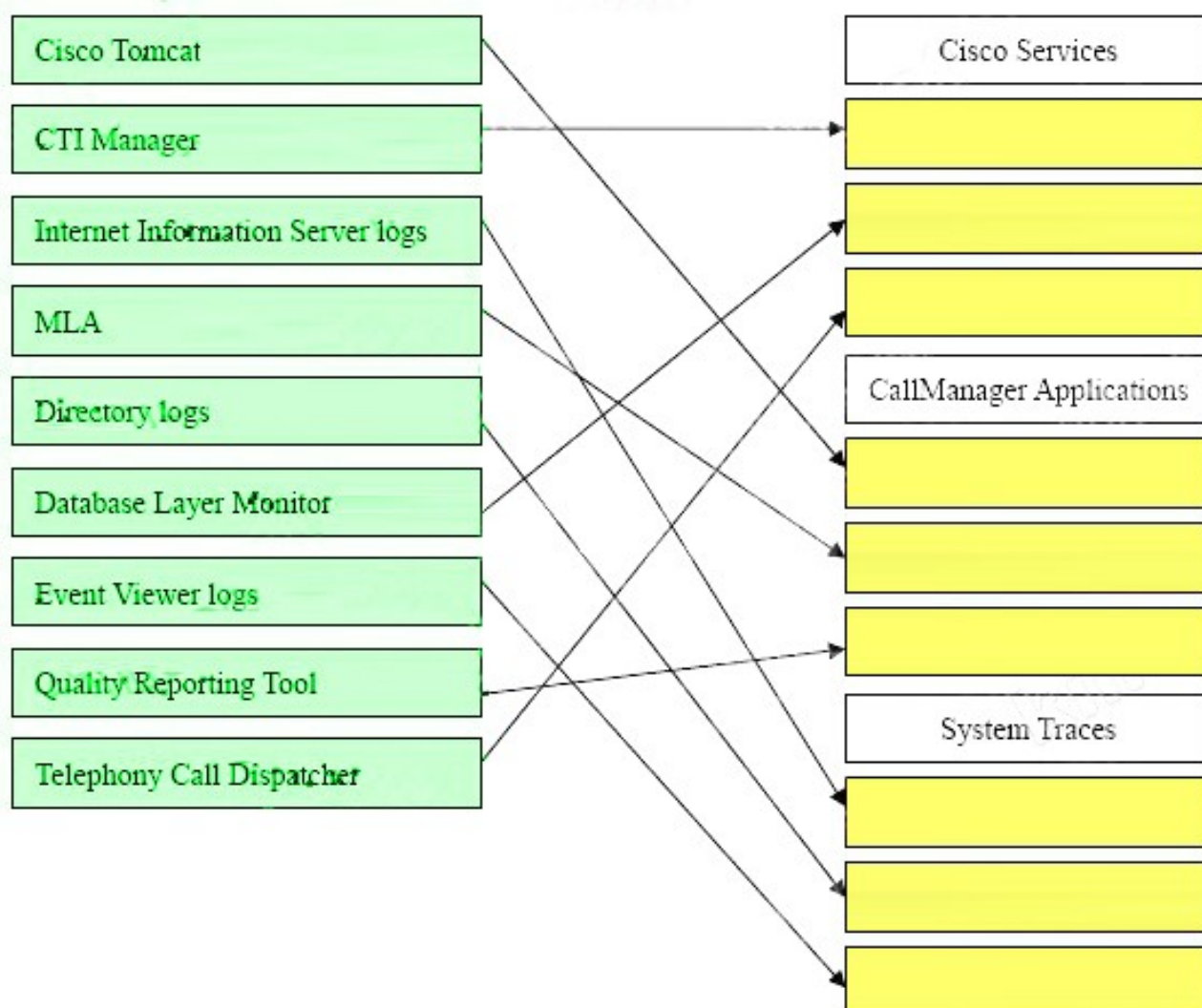
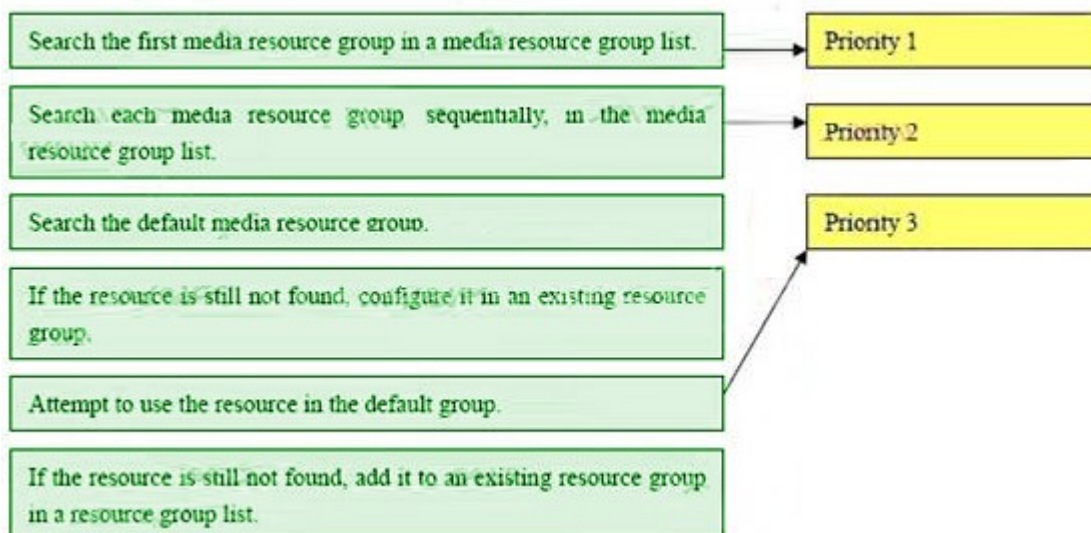

- A. H.225 Trunk (Gatekeeper Controlled)
- B. Inter-Cluster Trunk (Gatekeeper Controlled)
- C. Intra-Cluster Trunk (Gatekeeper Controlled)

D. H.323 Trunk (Gatekeeper Controlled)

E. H.245 Trunk (Gatekeeper Controlled)

Answer:AB

4. Refer to the exhibit. What CSS should be assigned to a phone in the Phones partition to block calls to international numbers while allowing all other calls?

```
Partition = Phones

Partition = Service
  Route Pattern X11

Partition = Local
  Route Pattern X11
  Route Pattern 9.0

Partition = LongDistance
  Route Pattern X11
  Route Pattern 9.[2-9]XXXXXX
  Route Pattern 9.1[2-9]XX[2-9]XXXXXX

Partition = International
  Route Pattern 9.011!
```

```
CSS A
  Phones
  Service

CSS B
  Service
  Local
  LongDistance

CSS C
  LongDistance

CSS D
  Phones
  LongDistance
```

A. CSS A

B. CSS B

C. CSS C

D. CSS D

Answer:D

5. An IP phone user has dialed "15152412232". Which of the following route patterns will be used?

A. 1515[^0-1]4[123]+

B. 1515[^0-2]4[012]+

C. 1515[^0-1]41[2232]

D. 1515[^0-2]412[012]+

E. will not match any of these patterns

Answer:A

6. Which three of the following can be assigned a partition? (Choose three.)

- A. gateway
- B. directory number
- C. translation pattern
- D. route pattern
- E. IP phone

Answer:BCD

7. A dial plan uses six-digit numbers where the first two digits are an access code and the last four digits are an extension. Access codes must begin with 7 or 8 and the second digit cannot be 0, 1, 5, or 9. Which two routepatterns will support this dial-plan requirement? (Choose two.)

- A. [78][2-4,6-8].XXXX
- B. [7-8][^0159].XXXX
- C. [^0-6,9][2-4,6-8].XXXX
- D. [^0-69][2-4678].XXXX
- E. [^78][^234678].XXXX

Answer:BD

8. When a phone needs a conference resource, which of the following Cisco CallManager objects is queried first? A. media resource device list B. media resource pool C. media resource group list D. media resource group

Answer:C 9. Which multiple line appearance parameter sets a number of calls per line beyond which all incoming calls are forwarded?

- A. Maximum Number of Calls
- B. Call Forward Busy
- C. No Answer Ring Duration
- D. Busy Trigger

Answer:D

10. Which two of these options can you use to prevent toll fraud? (Choose two.)

- A. Call Forward CSS
- B. IPSec encryption
- C. MLA
- D. forced authentication codes
- E. Call Transfer CSS

Answer:AD

11. Which two items can a route pattern be assigned? (Choose two.)

- A. gatekeepers that do not perform gateway functions
- B. route groups that contain one or more route filters
- C. gateways
- D. route lists that contain one or more route groups
- E. route filters
- F. route lists that contain one or more route filters

Answer:CD

12. You are working with a customer to deploy a pilot network to test how Cisco CallManager interoperates with SIP. Which two components need to be deployed for Cisco CallManager to interoperate with the SIP portion of the network? (Choose two.)

- A. Registrar server
- B. SIP to H.323 trunk
- C. SIP trunk
- D. proxy server
- E. redirect server
- F. location database

Answer:CD

13. A Cisco CallManager cluster contains one publisher and four subscribers. If the publisher is unavailable, which three of these statements are true? (Choose three.)

- A. The Microsoft SQL Server 2000 database automatically locks.
- B. New Cisco CallManager devices can be configured.
- C. The Microsoft SQL Server 2000 will save configuration changes on subscribers to be uploaded to the publisher when available.
- D. CDR collection is temporarily suspended on subscribers.
- E. All IP telephony devices continue to operate.
- F. Available Cisco CallManagers work from the local backup database.

Answer:AEF

14. Which three of these options correctly describe the role of a subscriber in a Cisco CallManager cluster? (Choose three.)

- A. replicates database to other Cisco CallManager servers
- B. maintains read-only copies of the configuration database
- C. processes IP telephony calls
- D. collects CDRs
- E. can have only one in a Cisco CallManager cluster
- F. maintains writeable copy of the configuration database

Answer:BCD

15. Which two of these services should be disabled during post-installation of Cisco CallManager to prevent potential intruders from finding server vulnerabilities? (Choose two.)

- A. Distributed File System
- B. FTP Publishing Service
- C. SSL Security Service
- D. Forward Publishing Service
- E. SRTP service
- F. SRCP service

Answer:AB

16. Which two of these events describe the relationship of an IP Phone to its secondary Cisco CallManager?(Choose two.)

- A. IP Phone sends a TCP keepalive message every 30 seconds.
- B. IP Phone sends a TCP keepalive message every 60 seconds.
- C. IP Phone sends a TCP connect message.
- D. IP Phone registers with secondary when primary is unavailable.
- E. IP Phone registers with primary when secondary is unavailable.
- F. IP Phone registers with all CallManagers initially including secondary.

Answer:CD

17. An auto parts retailer would like their service counter representatives to be able to assist both walk-up customers and telephone customers. Each store has six service counter representatives. Which call distribution algorithm will allow each service counter representative to provide the best customerservice?

- A. Top Down
- B. Circular
- C. Longest Idle Time
- D. Broadcast

Answer:D

18. An auto parts retailer would like their service counter representatives to assist both walk-up customers and telephone customers. Each store has six service counter representatives. Walk-up customers frequently engage allthe counter representatives and management is concerned that telephone customer business is being lost. From the list below, choose the appropriate call distribution algorithm and the appropriate call forwardingtreatment which will allow each store to provide the best customer service. (Choose two.)

- A. When hunting is exhausted, apply CFB and CFNA to the DN for the warehouse order puller.
- B. There is no need to configure CFB or CFNA; when hunting is exhausted, the call will automatically be routedto the warehouse order puller.
- C. Top Down
- D. Circular
- E. Longest Idle TimeF. Broadcast

Answer:AF

19. You are working with a customer to develop the methodology to secure IP Phones at their new research facility.They will be providing IP Phones in their lobby for vendor and guest use. Which two of these IP Phone hardening methods should be applied to these devices? (Choose two.)

- A. Enable GARP.
- B. Disable PC port on phone.
- C. Use signed IP phone firmware.
- D. Disable the Directory button.
- E. Disable the Services button on the IP phone.

Answer:BC

20. Which three options can you use to assign a softkey template? (Choose three.)

- A. Device > Phone Configuration
- B. Device > Device Settings > Device Profile
- C. Service > Service Parameters
- D. System > Device Defaults Configuration
- E. System > Device Pool Configuration
- F. System > Enterprise Parameters

Answer:ABE